



OM-259 158B

2013-02

Processes



MIG (GMAW) Welding

Flux Cored (FCAW) Welding

Description



Arc Welding Power Source and
Wire Feeder

Migmatic 175

CE

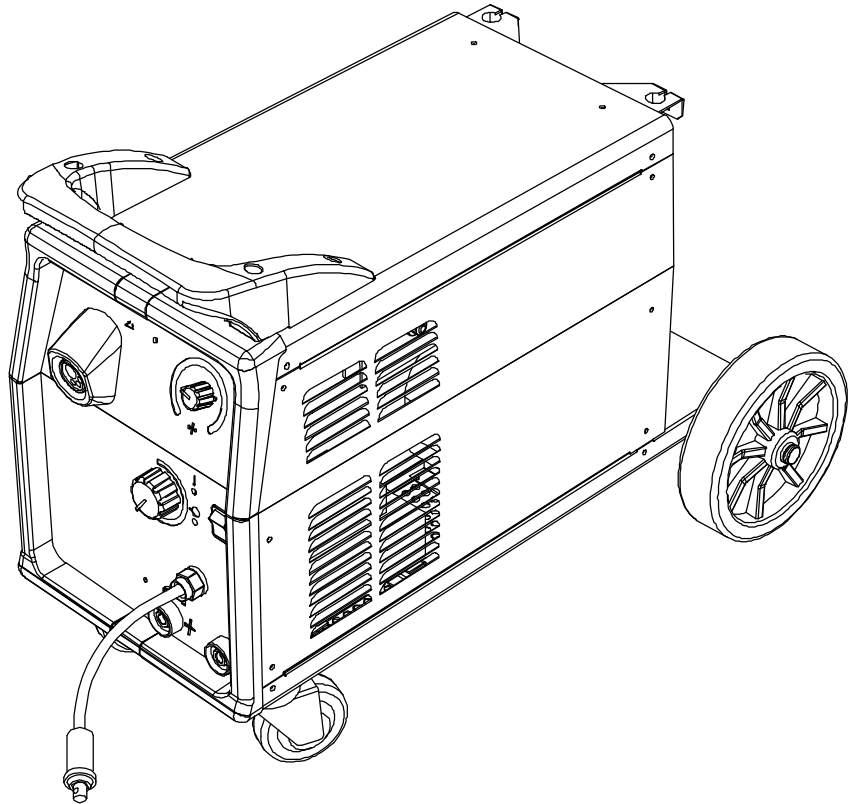

Visit our website at
www.MillerWelds.com

OWNER'S MANUAL

From Miller to You

Thank you and congratulations on choosing Miller. Now you can get the job done and get it done right. We know you don't have time to do it any other way.

That's why when Niels Miller first started building arc welders in 1929, he made sure his products offered long-lasting value and superior quality. Like you, his customers couldn't afford anything less. Miller products had to be more than the best they could be. They had to be the best you could buy.

Today, the people that build and sell Miller products continue the tradition. They're just as committed to providing equipment and service that meets the high standards of quality and value established in 1929.

This Owner's Manual is designed to help you get the most out of your Miller products. Please take time to read the Safety precautions. They will help you protect yourself against potential hazards on the worksite. We've made installation and operation quick and easy. With Miller you can count on years of reliable service with proper maintenance. And if for some reason the unit needs repair, there's a Troubleshooting section that will help you figure out what the problem is. The parts list will then help you to decide which exact part you may need to fix the problem. Warranty and service information for your particular model are also provided.



Miller Electric manufactures a full line of welders and welding related equipment. For information on other quality Miller products, contact your local Miller distributor to receive the latest full line catalog or individual catalog sheets.



Working as hard as you do – every power source from Miller is backed by the most hassle-free warranty in the business.



TABLE OF CONTENTS

SECTION 1 – SAFETY PRECAUTIONS - READ BEFORE USING	1
1-1. Symbol Usage	1
1-2. Arc Welding Hazards	1
1-3. Additional Symbols For Installation, Operation, And Maintenance	3
1-4. California Proposition 65 Warnings	4
1-5. Principal Safety Standards	4
1-6. EMF Information	4
SECTION 2 – DEFINITIONS	5
2-1. Additional Safety Symbols And Definitions	5
2-2. Miscellaneous Symbols And Definitions	6
SECTION 3 – INSTALLATION	7
3-1. Important Information Regarding CE Products (Sold Within The EU)	7
3-2. Specifications	7
3-3. Serial Number And Rating Label Location	8
3-4. Selecting A Location	8
3-5. Duty Cycle and Overheating	9
3-6. Volt-Ampere Curves	9
3-7. Installing Gas Supply	10
3-8. Changing Drive Roll and Wire Inlet Guide	11
3-9. Aligning Drive Rolls and Wire Guide	11
3-10. Threading Welding Wire And Adjusting Pressure Roll Tension	12
3-11. Electrical Service Guide	13
3-12. Connecting 1-Phase Input Power For 230 VAC	14
SECTION 4 – OPERATION	16
4-1. Controls	16
SECTION 5 – MAINTENANCE AND TROUBLESHOOTING	17
5-1. Unit Overload	17
5-2. Troubleshooting	17
SECTION 6 – ELECTRICAL DIAGRAM	18
SECTION 7 – PARTS LIST	19
WARRANTY	



DECLARATION OF CONFORMITY

for European Community (CE marked) products.

ITW Welding Products Italy S.r.l Via Privata Iseo 6/E, 20098 San Giuliano M.se, (MI) Italy declares that the product(s) identified in this declaration conform to the essential requirements and provisions of the stated Council Directive(s) and Standard(s).

Product/Apparatus Identification:

Product	Stock Number
MIGMATIC 175, 230VAC	029015550

Council Directives:

- 2006/95/EC Low Voltage
- 2004/108/EC Electromagnetic Compatibility
- 2011/65/EU Restriction of the use of certain hazardous substances in electrical and electronic equipment

Standards:

- IEC 60974-1 Arc Welding Equipment - Welding Power Sources: edition 3, 2005-07.
- IEC 60974-5 Arc Welding Equipment – Wire Feeders: edition 2, 2007-11.
- IEC 60974-10 Arc Welding Equipment - Electromagnetic Compatibility Requirements: edition 2.0, 2007-08.
- EN 50445:2008 Product family standard to demonstrate compliance of equipment for resistance welding, arc welding and allied processes with the basic restrictions related to human exposure to electromagnetic fields (0Hz-300Hz)

EU Signatory:

February 25th, 2013

Massimiliano Lavarini

Date of Declaration

ELECTRONIC ENGINEER R&D TECH. SUPPORT

956 172 099

SECTION 1 – SAFETY PRECAUTIONS - READ BEFORE USING

som 2011-10

 Protect yourself and others from injury — read, follow, and save these important safety precautions and operating instructions.

1-1. Symbol Usage

 **DANGER!** – Indicates a hazardous situation which, if not avoided, will result in death or serious injury. The possible hazards are shown in the adjoining symbols or explained in the text.

 Indicates a hazardous situation which, if not avoided, could result in death or serious injury. The possible hazards are shown in the adjoining symbols or explained in the text.

NOTICE – Indicates statements not related to personal injury.

 Indicates special instructions.



This group of symbols means Warning! Watch Out! ELECTRIC SHOCK, MOVING PARTS, and HOT PARTS hazards. Consult symbols and related instructions below for necessary actions to avoid the hazards.

1-2. Arc Welding Hazards

 The symbols shown below are used throughout this manual to call attention to and identify possible hazards. When you see the symbol, watch out, and follow the related instructions to avoid the hazard. The safety information given below is only a summary of the more complete safety information found in the Safety Standards listed in Section 1-5. Read and follow all Safety Standards.

 Only qualified persons should install, operate, maintain, and repair this unit.

 During operation, keep everybody, especially children, away.



ELECTRIC SHOCK can kill.

Touching live electrical parts can cause fatal shocks or severe burns. The electrode and work circuit is electrically live whenever the output is on. The input power circuit and machine internal circuits are also live when power is on. In semiautomatic or automatic wire welding, the wire, wire reel, drive roll housing, and all metal parts touching the welding wire are electrically live. Incorrectly installed or improperly grounded equipment is a hazard.

- Do not touch live electrical parts.

- Wear dry, hole-free insulating gloves and body protection.
- Insulate yourself from work and ground using dry insulating mats or covers big enough to prevent any physical contact with the work or ground.
- Do not use AC output in damp areas, if movement is confined, or if there is a danger of falling.
- Use AC output ONLY if required for the welding process.
- If AC output is required, use remote output control if present on unit.
- Additional safety precautions are required when any of the following electrically hazardous conditions are present: in damp locations or while wearing wet clothing; on metal structures such as floors, gratings, or scaffolds; when in cramped positions such as sitting, kneeling, or lying; or when there is a high risk of unavoidable or accidental contact with the workpiece or ground. For these conditions, use the following equipment in order presented: 1) a semiautomatic DC constant voltage (wire) welder, 2) a DC manual (stick) welder, or 3) an AC welder with reduced open-circuit voltage. In most situations, use of a DC, constant voltage wire welder is recommended. And, do not work alone!
- Disconnect input power or stop engine before installing or servicing this equipment. Lockout/tagout input power according to OSHA 29 CFR 1910.147 (see Safety Standards).
- Properly install, ground, and operate this equipment according to its Owner's Manual and national, state, and local codes.

- Always verify the supply ground – check and be sure that input power cord ground wire is properly connected to ground terminal in disconnect box or that cord plug is connected to a properly grounded receptacle outlet.
- When making input connections, attach proper grounding conductor first – double-check connections.
- Keep cords dry, free of oil and grease, and protected from hot metal and sparks.
- Frequently inspect input power cord for damage or bare wiring – replace cord immediately if damaged – bare wiring can kill.
- Turn off all equipment when not in use.
- Do not use worn, damaged, undersized, or poorly spliced cables.
- Do not drape cables over your body.
- If earth grounding of the workpiece is required, ground it directly with a separate cable.
- Do not touch electrode if you are in contact with the work, ground, or another electrode from a different machine.
- Do not touch electrode holders connected to two welding machines at the same time since double open-circuit voltage will be present.
- Use only well-maintained equipment. Repair or replace damaged parts at once. Maintain unit according to manual.
- Wear a safety harness if working above floor level.
- Keep all panels and covers securely in place.
- Clamp work cable with good metal-to-metal contact to workpiece or worktable as near the weld as practical.
- Insulate work clamp when not connected to workpiece to prevent contact with any metal object.
- Do not connect more than one electrode or work cable to any single weld output terminal. Disconnect cable for process not in use.

SIGNIFICANT DC VOLTAGE exists in inverter welding power sources AFTER removal of input power.

- Turn Off inverter, disconnect input power, and discharge input capacitors according to instructions in Maintenance Section before touching any parts.



HOT PARTS can burn.

- Do not touch hot parts bare handed.
- Allow cooling period before working on equipment.
- To handle hot parts, use proper tools and/or wear heavy, insulated welding gloves and clothing to prevent burns.



FUMES AND GASES can be hazardous.

Welding produces fumes and gases. Breathing these fumes and gases can be hazardous to your health.

- Keep your head out of the fumes. Do not breathe the fumes.
- If inside, ventilate the area and/or use local forced ventilation at the arc to remove welding fumes and gases.
- If ventilation is poor, wear an approved air-supplied respirator.
- Read and understand the Material Safety Data Sheets (MSDSs) and the manufacturer's instructions for metals, consumables, coatings, cleaners, and degreasers.
- Work in a confined space only if it is well ventilated, or while wearing an air-supplied respirator. Always have a trained watch-person nearby. Welding fumes and gases can displace air and lower the oxygen level causing injury or death. Be sure the breathing air is safe.
- Do not weld in locations near degreasing, cleaning, or spraying operations. The heat and rays of the arc can react with vapors to form highly toxic and irritating gases.
- Do not weld on coated metals, such as galvanized, lead, or cadmium plated steel, unless the coating is removed from the weld area, the area is well ventilated, and while wearing an air-supplied respirator. The coatings and any metals containing these elements can give off toxic fumes if welded.



ARC RAYS can burn eyes and skin.

Arc rays from the welding process produce intense visible and invisible (ultraviolet and infrared) rays that can burn eyes and skin. Sparks fly off from the weld.

- Wear an approved welding helmet fitted with a proper shade of filter lenses to protect your face and eyes from arc rays and sparks when welding or watching (see ANSI Z49.1 and Z87.1 listed in Safety Standards).
- Wear approved safety glasses with side shields under your helmet.
- Use protective screens or barriers to protect others from flash, glare and sparks; warn others not to watch the arc.
- Wear protective clothing made from durable, flame-resistant material (leather, heavy cotton, or wool) and foot protection.



WELDING can cause fire or explosion.

Welding on closed containers, such as tanks, drums, or pipes, can cause them to blow up. Sparks can fly off from the welding arc. The flying sparks, hot workpiece, and hot equipment can cause fires and burns. Accidental contact of electrode to metal objects can cause sparks, explosion, overheating, or fire. Check and be sure the area is safe before doing any welding.

- Remove all flammables within 35 ft (10.7 m) of the welding arc. If this is not possible, tightly cover them with approved covers.
- Do not weld where flying sparks can strike flammable material.
- Protect yourself and others from flying sparks and hot metal.
- Be alert that welding sparks and hot materials from welding can easily go through small cracks and openings to adjacent areas.
- Watch for fire, and keep a fire extinguisher nearby.
- Be aware that welding on a ceiling, floor, bulkhead, or partition can cause fire on the hidden side.
- Do not weld on containers that have held combustibles, or on closed containers such as tanks, drums, or pipes unless they are properly prepared according to AWS F4.1 and AWS A6.0 (see Safety Standards).
- Do not weld where the atmosphere may contain flammable dust, gas, or liquid vapors (such as gasoline).
- Connect work cable to the work as close to the welding area as practical to prevent welding current from traveling long, possibly unknown paths and causing electric shock, sparks, and fire hazards.
- Do not use welder to thaw frozen pipes.

- Remove stick electrode from holder or cut off welding wire at contact tip when not in use.
- Wear oil-free protective garments such as leather gloves, heavy shirt, cuffless trousers, high shoes, and a cap.
- Remove any combustibles, such as a butane lighter or matches, from your person before doing any welding.
- After completion of work, inspect area to ensure it is free of sparks, glowing embers, and flames.
- Use only correct fuses or circuit breakers. Do not oversize or bypass them.
- Follow requirements in OSHA 1910.252 (a) (2) (iv) and NFPA 51B for hot work and have a fire watcher and extinguisher nearby.

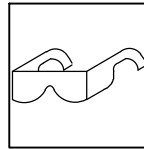

FLYING METAL or DIRT can injure eyes.

- Welding, chipping, wire brushing, and grinding cause sparks and flying metal. As welds cool, they can throw off slag.
- Wear approved safety glasses with side shields even under your welding helmet.



BUILDUP OF GAS can injure or kill.

- Shut off compressed gas supply when not in use.
- Always ventilate confined spaces or use approved air-supplied respirator.

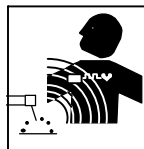

ELECTRIC AND MAGNETIC FIELDS (EMF) can affect Implanted Medical Devices.

- Wearers of Pacemakers and other Implanted Medical Devices should keep away.
- Implanted Medical Device wearers should consult their doctor and the device manufacturer before going near arc welding, spot welding, gouging, plasma arc cutting, or induction heating operations.

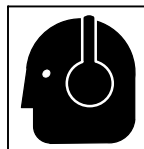

NOISE can damage hearing.

Noise from some processes or equipment can damage hearing.

- Wear approved ear protection if noise level is high.

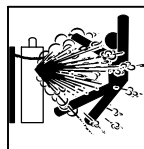

CYLINDERS can explode if damaged.

Compressed gas cylinders contain gas under high pressure. If damaged, a cylinder can explode. Since gas cylinders are normally part of the welding process, be sure to treat them carefully.

- Protect compressed gas cylinders from excessive heat, mechanical shocks, physical damage, slag, open flames, sparks, and arcs.
- Install cylinders in an upright position by securing to a stationary support or cylinder rack to prevent falling or tipping.
- Keep cylinders away from any welding or other electrical circuits.
- Never drape a welding torch over a gas cylinder.
- Never allow a welding electrode to touch any cylinder.
- Never weld on a pressurized cylinder – explosion will result.
- Use only correct compressed gas cylinders, regulators, hoses, and fittings designed for the specific application; maintain them and associated parts in good condition.
- Turn face away from valve outlet when opening cylinder valve.
- Keep protective cap in place over valve except when cylinder is in use or connected for use.
- Use the right equipment, correct procedures, and sufficient number of persons to lift and move cylinders.
- Read and follow instructions on compressed gas cylinders, associated equipment, and Compressed Gas Association (CGA) publication P-1 listed in Safety Standards.

1-3. Additional Symbols For Installation, Operation, And Maintenance



FIRE OR EXPLOSION hazard.

- Do not install or place unit on, over, or near combustible surfaces.
- Do not install unit near flammables.
- Do not overload building wiring – be sure power supply system is properly sized, rated, and protected to handle this unit.



FALLING EQUIPMENT can injure.

- Use lifting eye to lift unit only, NOT running gear, gas cylinders, or any other accessories.
- Use equipment of adequate capacity to lift and support unit.
- If using lift forks to move unit, be sure forks are long enough to extend beyond opposite side of unit.
- Keep equipment (cables and cords) away from moving vehicles when working from an aerial location.
- Follow the guidelines in the Applications Manual for the Revised NIOSH Lifting Equation (Publication No. 94-110) when manually lifting heavy parts or equipment.

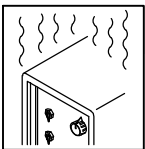

OVERUSE can cause OVERHEATING

- Allow cooling period; follow rated duty cycle.
- Reduce current or reduce duty cycle before starting to weld again.
- Do not block or filter airflow to unit.

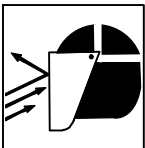

FLYING SPARKS can injure.

- Wear a face shield to protect eyes and face.
- Shape tungsten electrode only on grinder with proper guards in a safe location wearing proper face, hand, and body protection.
- Sparks can cause fires — keep flammables away.

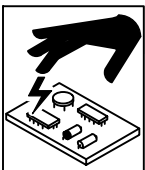

STATIC (ESD) can damage PC boards.

- Put on grounded wrist strap BEFORE handling boards or parts.
- Use proper static-proof bags and boxes to store, move, or ship PC boards.



MOVING PARTS can injure.

- Keep away from moving parts.
- Keep away from pinch points such as drive rolls.



WELDING WIRE can injure.

- Do not press gun trigger until instructed to do so.
- Do not point gun toward any part of the body, other people, or any metal when threading welding wire.

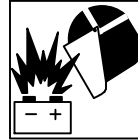

BATTERY EXPLOSION can injure.

- Do not use welder to charge batteries or jump start vehicles unless it has a battery charging feature designed for this purpose.



MOVING PARTS can injure.

- Keep away from moving parts such as fans.
- Keep all doors, panels, covers, and guards closed and securely in place.
- Have only qualified persons remove doors, panels, covers, or guards for maintenance and troubleshooting as necessary.
- Reinstall doors, panels, covers, or guards when maintenance is finished and before reconnecting input power.

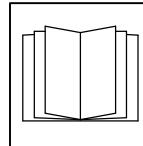

READ INSTRUCTIONS.

- Read and follow all labels and the Owner's Manual carefully before installing, operating, or servicing unit. Read the safety information at the beginning of the manual and in each section.
- Use only genuine replacement parts from the manufacturer.
- Perform maintenance and service according to the Owner's Manuals, industry standards, and national, state, and local codes.

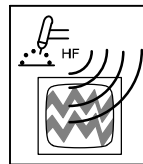

H.F. RADIATION can cause interference.

- High-frequency (H.F.) can interfere with radio navigation, safety services, computers, and communications equipment.
- Have only qualified persons familiar with electronic equipment perform this installation.
- The user is responsible for having a qualified electrician promptly correct any interference problem resulting from the installation.
- If notified by the FCC about interference, stop using the equipment at once.
- Have the installation regularly checked and maintained.
- Keep high-frequency source doors and panels tightly shut, keep spark gaps at correct setting, and use grounding and shielding to minimize the possibility of interference.

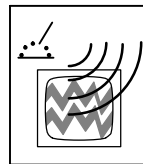

ARC WELDING can cause interference.

- Electromagnetic energy can interfere with sensitive electronic equipment such as computers and computer-driven equipment such as robots.
- Be sure all equipment in the welding area is electromagnetically compatible.
- To reduce possible interference, keep weld cables as short as possible, close together, and down low, such as on the floor.
- Locate welding operation 100 meters from any sensitive electronic equipment.
- Be sure this welding machine is installed and grounded according to this manual.
- If interference still occurs, the user must take extra measures such as moving the welding machine, using shielded cables, using line filters, or shielding the work area.

1-4. California Proposition 65 Warnings

 **Welding or cutting equipment produces fumes or gases which contain chemicals known to the State of California to cause birth defects and, in some cases, cancer. (California Health & Safety Code Section 25249.5 et seq.)**

 **This product contains chemicals, including lead, known to the state of California to cause cancer, birth defects, or other reproductive harm. Wash hands after use.**

1-5. Principal Safety Standards

Safety in Welding, Cutting, and Allied Processes, ANSI Standard Z49.1, is available as a free download from the American Welding Society at <http://www.aws.org> or purchased from Global Engineering Documents (phone: 1-877-413-5184, website: www.global.ihs.com).

Safe Practices for the Preparation of Containers and Piping for Welding and Cutting, American Welding Society Standard AWS F4.1, from Global Engineering Documents (phone: 1-877-413-5184, website: www.global.ihs.com).

Safe Practices for Welding and Cutting Containers that have Held Combustibles, American Welding Society Standard AWS A6.0, from Global Engineering Documents (phone: 1-877-413-5184, website: www.global.ihs.com).

National Electrical Code, NFPA Standard 70, from National Fire Protection Association, Quincy, MA 02269 (phone: 1-800-344-3555, website: www.nfpa.org and www.sparky.org).

Safe Handling of Compressed Gases in Cylinders, CGA Pamphlet P-1, from Compressed Gas Association, 14501 George Carter Way, Suite 103, Chantilly, VA 20151 (phone: 703-788-2700, website: www.cganet.com).

Safety in Welding, Cutting, and Allied Processes, CSA Standard W117.2, from Canadian Standards Association, Standards Sales, 5060

Spectrum Way, Suite 100, Ontario, Canada L4W 5N5 (phone: 800-463-6727, website: www.csa-international.org).

Safe Practice For Occupational And Educational Eye And Face Protection, ANSI Standard Z87.1, from American National Standards Institute, 25 West 43rd Street, New York, NY 10036 (phone: 212-642-4900, website: www.ansi.org).

Standard for Fire Prevention During Welding, Cutting, and Other Hot Work, NFPA Standard 51B, from National Fire Protection Association, Quincy, MA 02269 (phone: 1-800-344-3555, website: www.nfpa.org).

OSHA, Occupational Safety and Health Standards for General Industry, Title 29, Code of Federal Regulations (CFR), Part 1910, Subpart Q, and Part 1926, Subpart J, from U.S. Government Printing Office, Superintendent of Documents, P.O. Box 371954, Pittsburgh, PA 15250-7954 (phone: 1-866-512-1800) (there are 10 OSHA Regional Offices—phone for Region 5, Chicago, is 312-353-2220, website: www.osha.gov).

Applications Manual for the Revised NIOSH Lifting Equation, The National Institute for Occupational Safety and Health (NIOSH), 1600 Clifton Rd, Atlanta, GA 30333 (phone: 1-800-232-4636, website: www.cdc.gov/NIOSH).

1-6. EMF Information

Electric current flowing through any conductor causes localized electric and magnetic fields (EMF). Welding current creates an EMF field around the welding circuit and welding equipment. EMF fields may interfere with some medical implants, e.g. pacemakers. Protective measures for persons wearing medical implants have to be taken. For example, restrict access for passers-by or conduct individual risk assessment for welders. All welders should use the following procedures in order to minimize exposure to EMF fields from the welding circuit:

1. Keep cables close together by twisting or taping them, or using a cable cover.
2. Do not place your body between welding cables. Arrange cables to one side and away from the operator.
3. Do not coil or drape cables around your body.

4. Keep head and trunk as far away from the equipment in the welding circuit as possible.
5. Connect work clamp to workpiece as close to the weld as possible.
6. Do not work next to, sit or lean on the welding power source.
7. Do not weld whilst carrying the welding power source or wire feeder.









About Implanted Medical Devices:

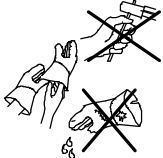
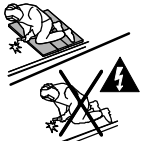
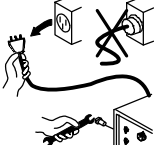

Implanted Medical Device wearers should consult their doctor and the device manufacturer before performing or going near arc welding, spot welding, gouging, plasma arc cutting, or induction heating operations. If cleared by your doctor, then following the above procedures is recommended.

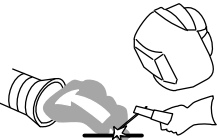
SECTION 2 – DEFINITIONS

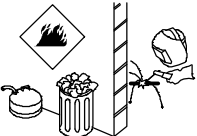





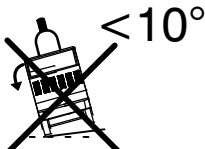
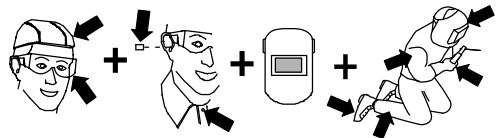
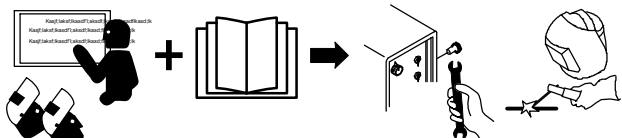









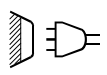

2-1. Additional Safety Symbols And Definitions

 Some symbols are found only on CE products.

	<p>Warning! Watch Out! There are possible hazards as shown by the symbols.</p> <p style="text-align: right;">Safe1 2012-05</p>
	<p>Do not discard product (where applicable) with general waste. Reuse or recycle Waste Electrical and Electronic Equipment (WEEE) by disposing at a designated collection facility. Contact your local recycling office or your local distributor for further information.</p> <p style="text-align: right;">Safe37 2012-05</p>
	<p>Wear dry insulating gloves. Do not touch electrode with bare hand. Do not wear wet or damaged gloves.</p> <p style="text-align: right;">Safe2 2012-05</p>
	<p>Protect yourself from electric shock by insulating yourself from work and ground.</p> <p style="text-align: right;">Safe3 2012-05</p>
	<p>Disconnect input plug or power before working on machine.</p> <p style="text-align: right;">Safe5 2012-05</p>
	<p>Keep your head out of the fumes.</p> <p style="text-align: right;">Safe6 2012-05</p>
	<p>Use forced ventilation or local exhaust to remove the fumes.</p> <p style="text-align: right;">Safe8 2012-05</p>
	<p>Use ventilating fan to remove fumes.</p> <p style="text-align: right;">Safe10 2012-05</p>
	<p>Keep flammables away from welding. Do not weld near flammables.</p> <p style="text-align: right;">Safe12 2012-05</p>
	<p>Welding sparks can cause fires. Have a fire extinguisher nearby, and have a watchperson ready to use it.</p> <p style="text-align: right;">Safe14 2012-05</p>

	Do not weld on drums or any closed containers.	Safe16 2012-05
	Do not remove or paint over (cover) the label.	Safe20 2012-05
	Falling unit can cause injury. Do not move or operate unit where it could tip.	Safe53 2012-05
	Wear hat and safety glasses. Use ear protection and button shirt collar. Use welding helmet with correct shade of filter. Wear complete body protection.	Safe38 2012-05
	Become trained and read the instructions before working on the machine or welding.	Safe40 2012-05

2-2. Miscellaneous Symbols And Definitions

A	Amperes	V	Volts		Alternating Current (AC)		Direct Current (DC)
	Gas Supply		Caution		GMAW Gun With Switch		Suitable For Welding In An Environment With Increased Risk Of Electric Shock
	Remote	I	On		Off		Protective Earth (Ground)
	Line Connection		Single Phase Transformer Rectifier		Single Phase		Gas Metal Arc Welding (GMAW)
U₁	Primary Voltage	I_{1max}	Rated Maximum Supply Current	I_{1eff}	Maximum Effective Supply Current	U₂	Conventional Load Voltage
I₂	Rated Welding Current	X	Duty Cycle	%	Percent	U₀	Rated No Load Voltage (Average)
IP	Degree Of Protection		Voltage Input		Wire Feed	Hz	Hertz
	Read Operator's Manual		Gas Input		Gas Output		Gas Type
+	Positive	-	Negative		Input		

3-3. Serial Number And Rating Label Location

The serial number and rating information for this product is located on the back. Use rating label to determine input power requirements and/or rated output. For future reference, write serial number in space provided on back cover of this manual.

3-4. Selecting A Location



1 Line Disconnect Device

Locate unit near correct input power supply.

⚠ Special installation may be required where gasoline or volatile liquids are present – see NEC Article 511 or CEC Section 20.

Tipping

⚠ Do not move or operate unit where it could tip.

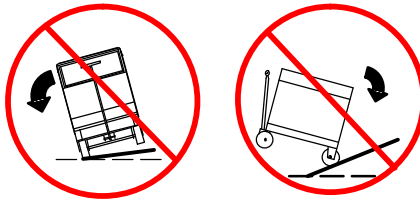

Location

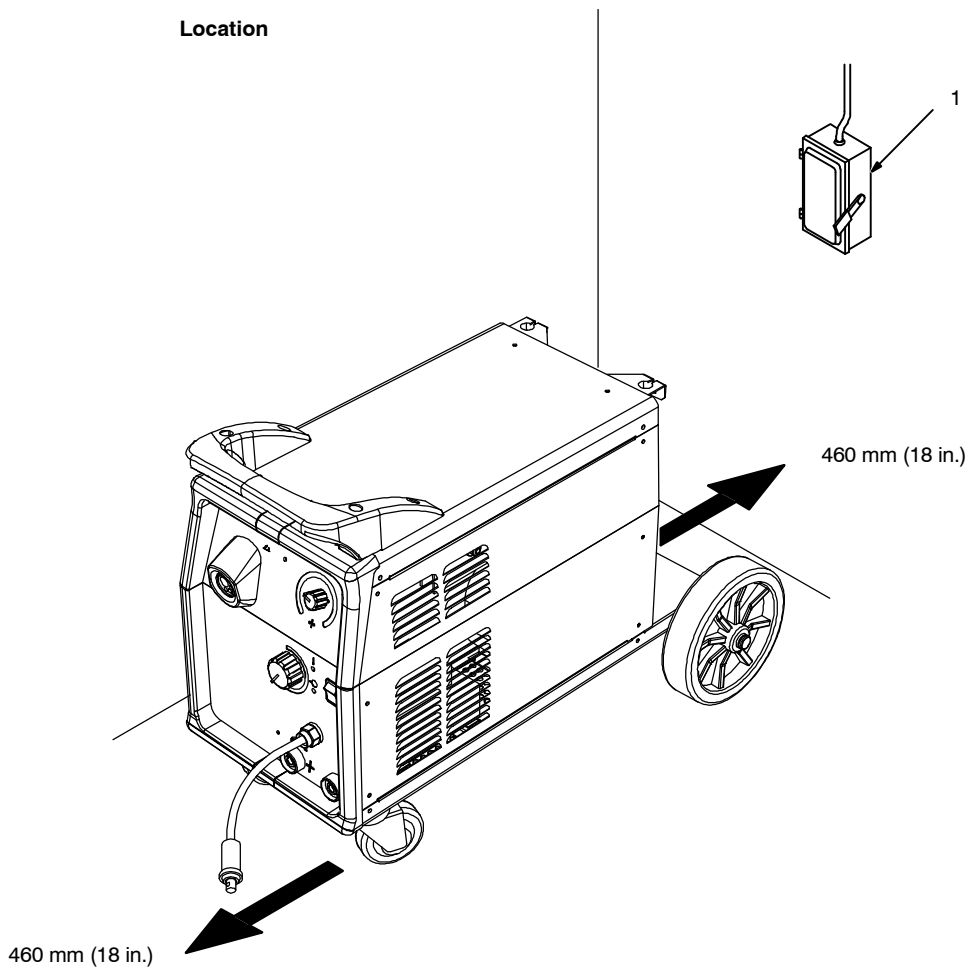

3-5. Duty Cycle and Overheating

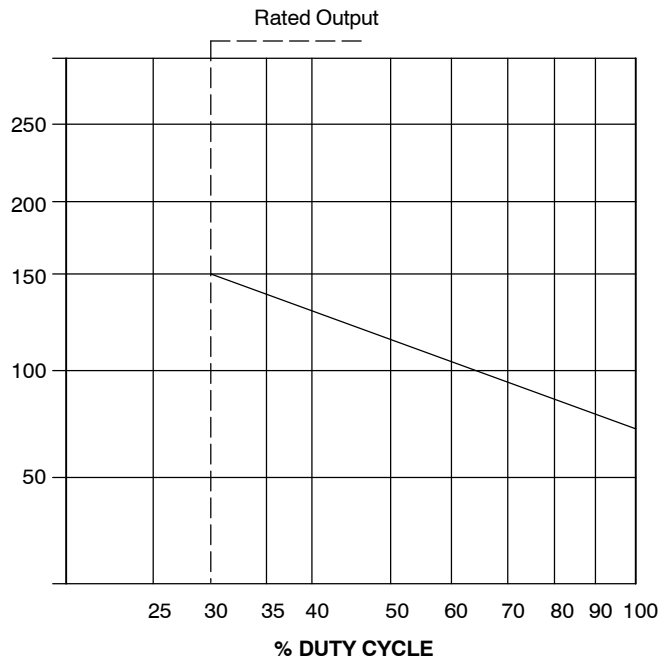

Duty Cycle is a percentage of 10 minutes that unit can weld at rated load without overheating.

If unit overheats, thermostat(s) opens, output stops, and cooling fan runs. Wait fifteen minutes for unit to cool. Reduce amperage or voltage, or duty cycle before welding.

NOTICE – Exceeding duty cycle can damage unit or gun and void warranty.

60% Duty Cycle at 100 Amperes

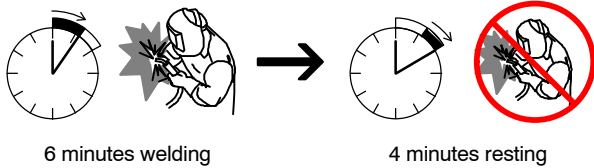

100% Duty Cycle at 60 Amperes



Overheating

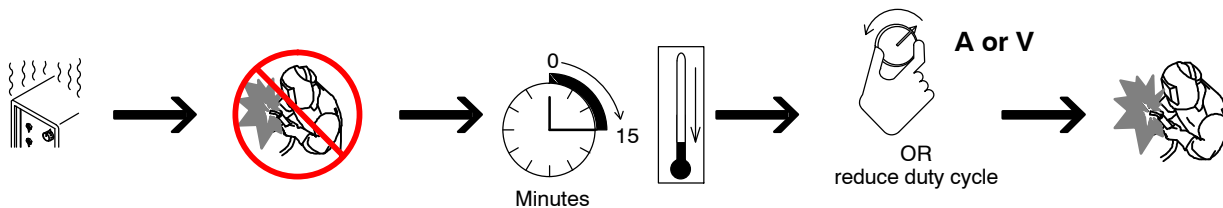

duty1 4/95 – SB-150 215

3-6. Volt-Ampere Curves

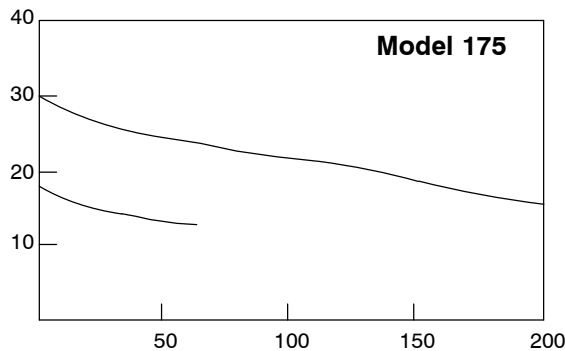

1 Normal Volt-Ampere Curves

The volt-ampere curves show the normal minimum and maximum voltage and amperage output capabilities of the welding power source. Curves of other settings fall between the curves shown.

2 Overload Volt-Ampere Curves

When unit is beyond capacity, circuitry senses the overload and shuts down unit output. Release trigger and lower weld voltage setting before trying to weld. This shut down circuitry protects internal circuits and parts from overload damage.

3-7. Installing Gas Supply

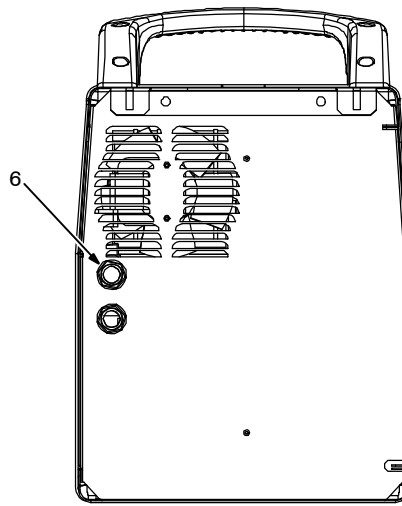
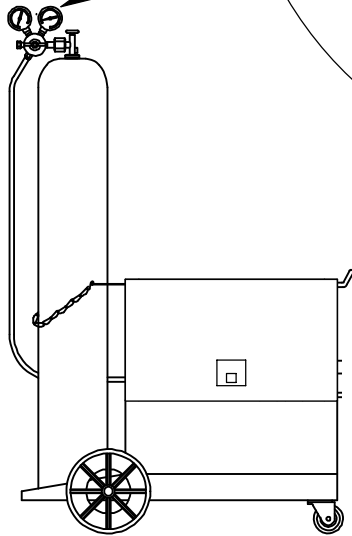
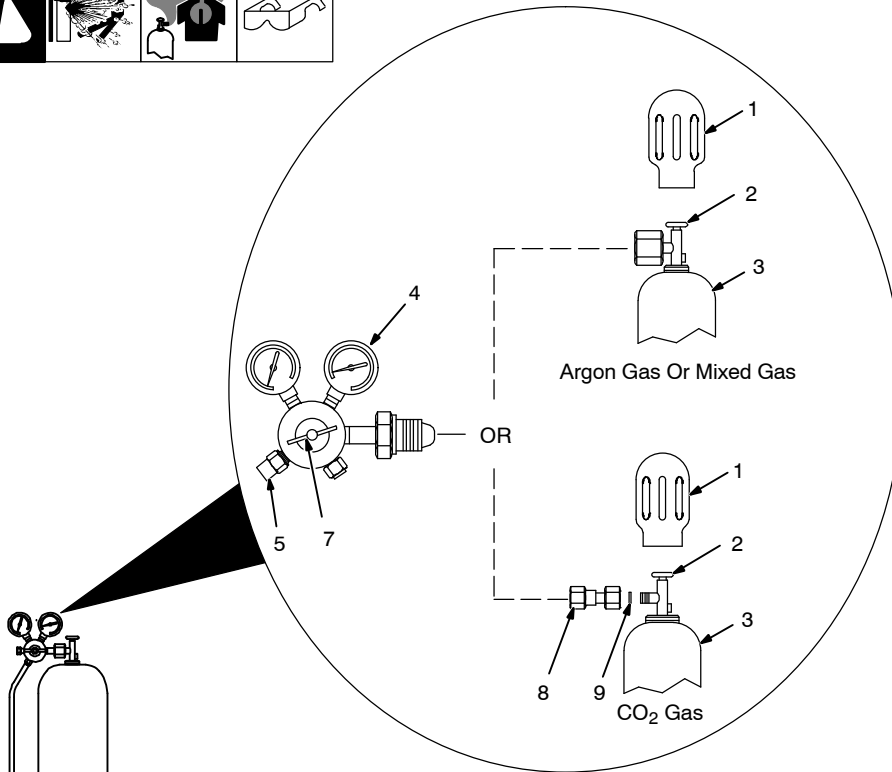

Rear Panel

Obtain gas cylinder and chain to running gear, wall, or other stationary support so cylinder cannot fall and break off valve.

- 1 Cap
- 2 Cylinder Valve

Remove cap, stand to side of valve, and open valve slightly. Gas flow blows dust and dirt from valve. Close valve.

- 3 Cylinder
- 4 Regulator/Flowmeter

Install so face is vertical.

- 5 Regulator/Flowmeter Gas Hose Connection

- 6 Welding Power Source Gas Hose Connection

Connect supplied gas hose between regulator/flowmeter gas hose connection, and fitting on rear of welding power source.

- 7 Flow Adjust

Typical flow rate is between 15-20 liters per minute. Check wire manufacturer's recommended flow rate.

- 8 CO₂ Adapter (Customer Supplied)

- 9 O-Ring (Customer Supplied)

Install adapter with O-ring between regulator/flowmeter and CO₂ cylinder.

3-8. Changing Drive Roll and Wire Inlet Guide

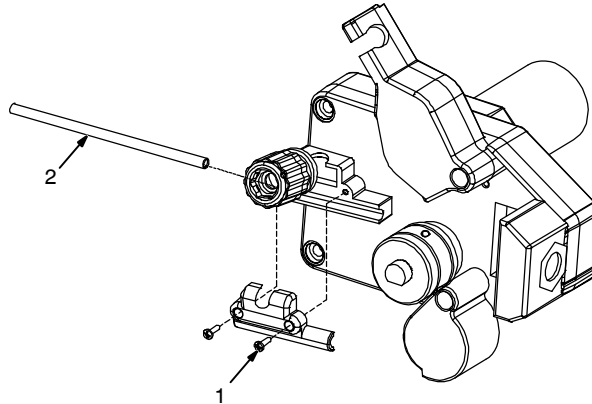
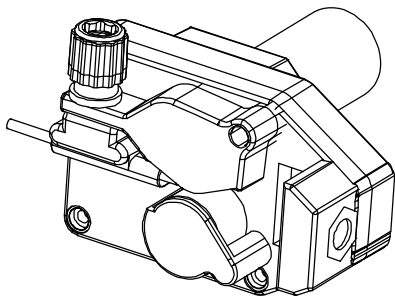

Tools Needed:



1 Wire Guide Securing Screw

2 Inlet Wire Guide

Loosen screw. Slide tip as close to drive rolls as possible without touching. Tighten screw.

3 Drive Roll

The drive roll consists of two different sized grooves. The stamped markings on the end surface of the drive roll refers to the grooves on the opposite side of the drive roll. The grooves closest to the motor shaft is the proper groove to thread.

4 Drive Roll Securing Screw

Loosen screw and remove drive roll.

Tools Needed:

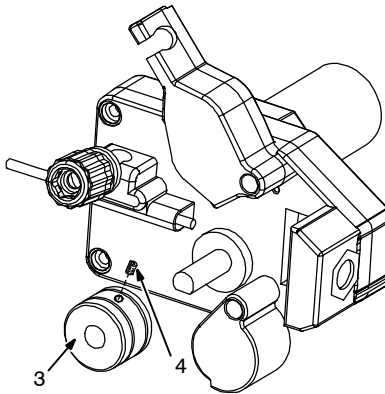
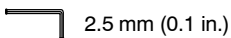

956142945-5-A

3-9. Aligning Drive Rolls and Wire Guide

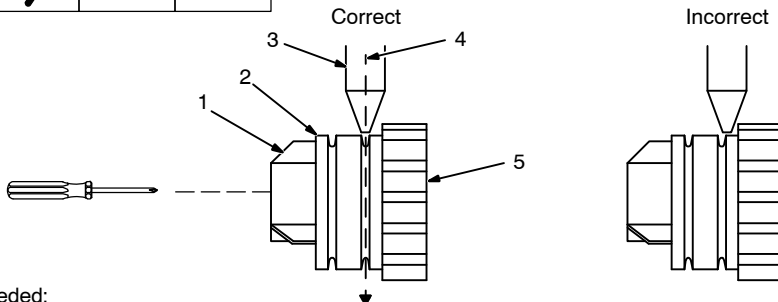

Tools Needed:



⚠ Turn off and disconnect input power

View is from top of drive rolls looking down with pressure assembly open.

1 Drive Roll Securing Nut

2 Drive Roll

3 Wire Guide

4 Welding Wire

5 Drive Gear

Insert screwdriver, and turn screw in or out until drive roll groove lines up with wire guide.

Close pressure roll assembly.

Ref. 800 412-A

3-10. Threading Welding Wire And Adjusting Pressure Roll Tension



- 1 Wire Spool
 - 2 Welding Wire
 - 3 Inlet Wire Guide
 - 4 Pressure Adjustment Knob
 - 5 Drive Roll
 - 6 Outlet Wire Guide
 - 7 Gun Conduit Cable
- Lay gun cable out straight.

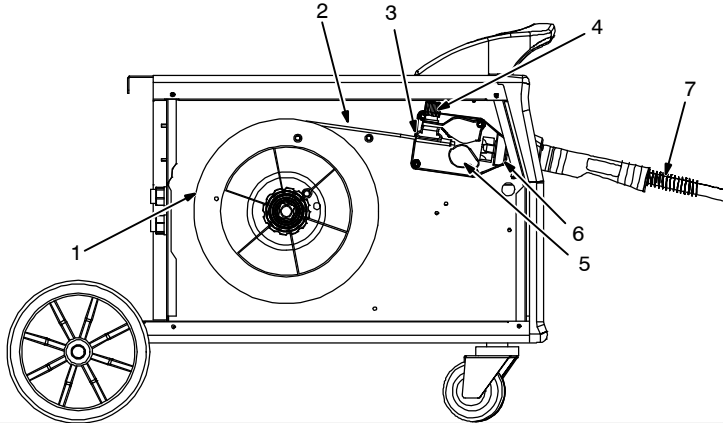

Tools Needed:

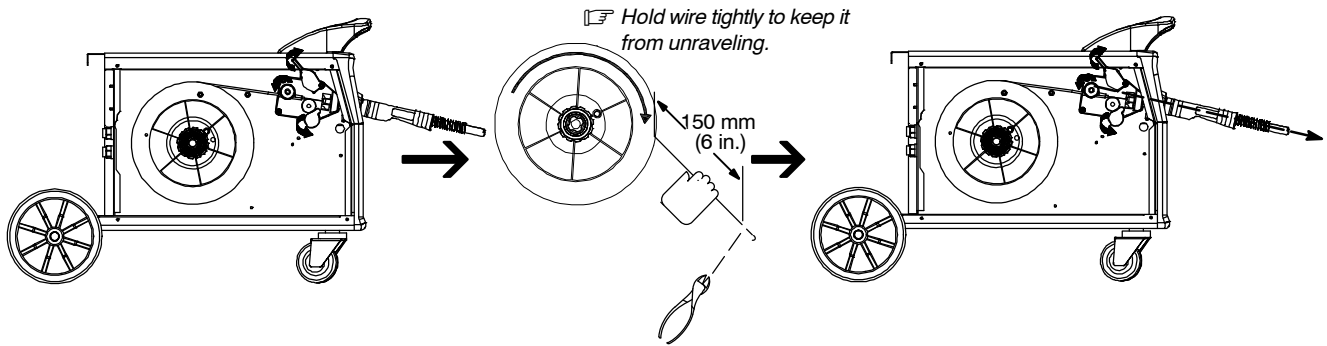
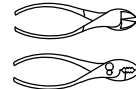

Open pressure assembly.

Pull and hold wire; cut off end.

Push wire thru guides into gun; continue to hold wire.

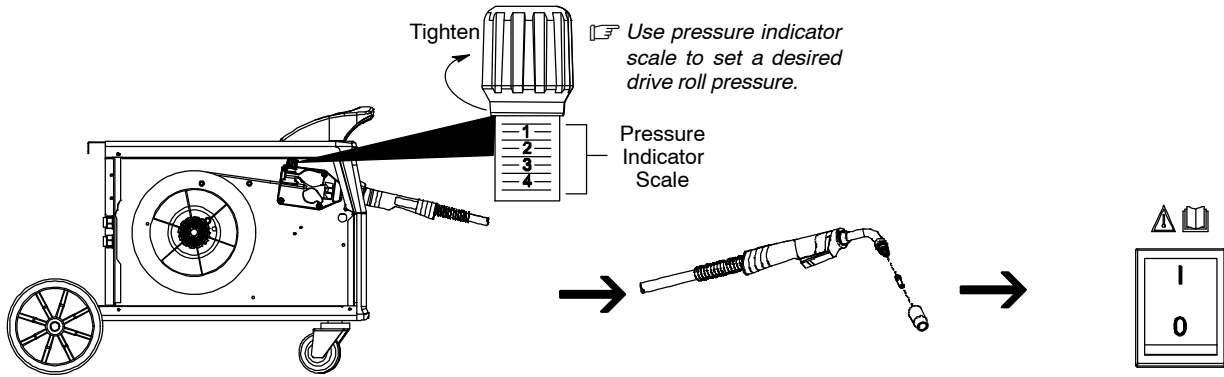

Close and tighten pressure assembly, and let go of wire.

Remove gun nozzle and contact tip.

Turn On.

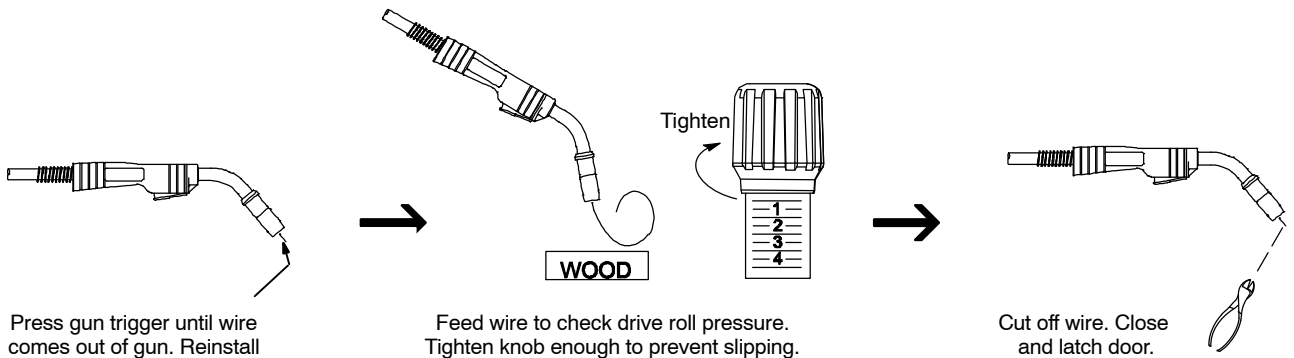

Press gun trigger until wire comes out of gun. Reinstall contact tip and nozzle

Feed wire to check drive roll pressure. Tighten knob enough to prevent slipping.

Cut off wire. Close and latch door.

3-12. Connecting 1-Phase Input Power For 230 VAC

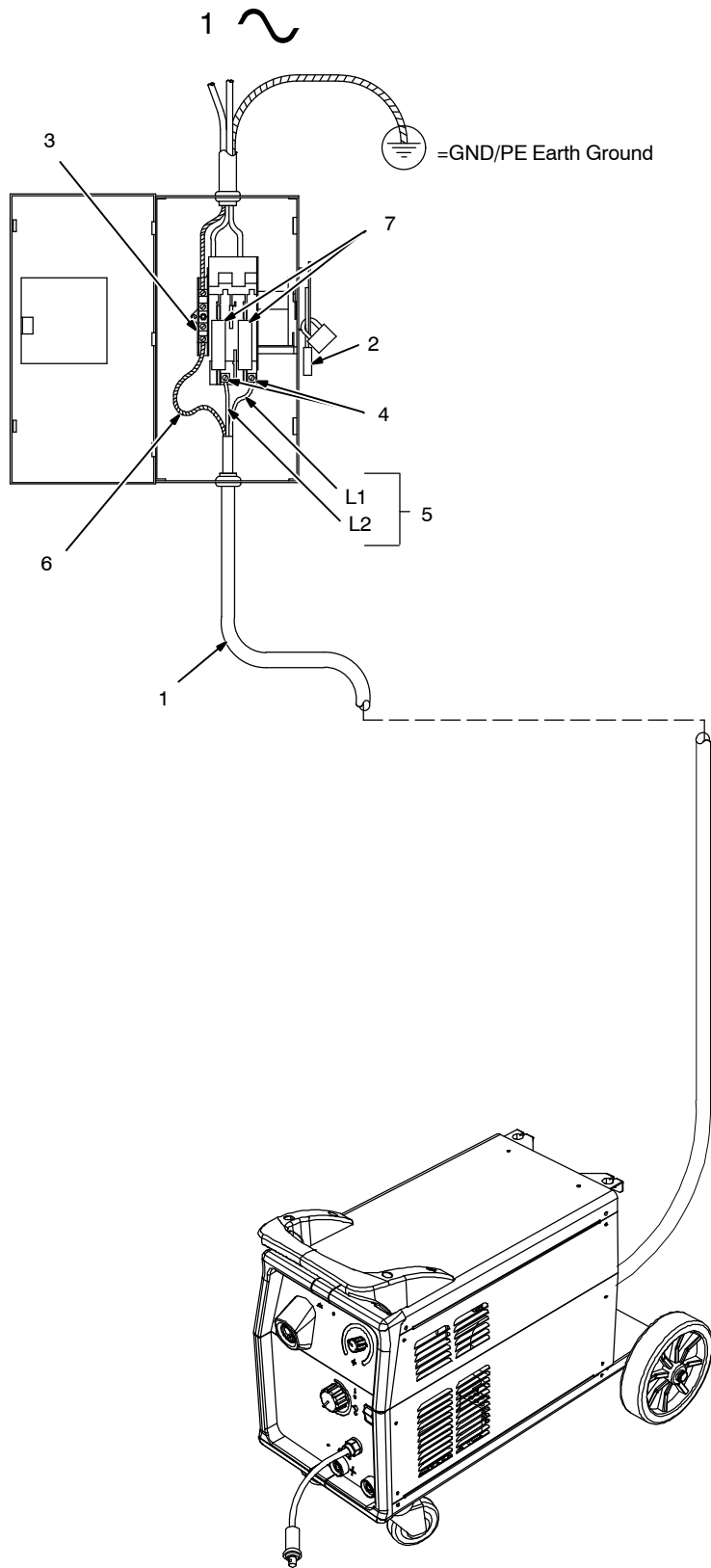

Tools Needed:



SECTION 4 – OPERATION

4-1. Controls





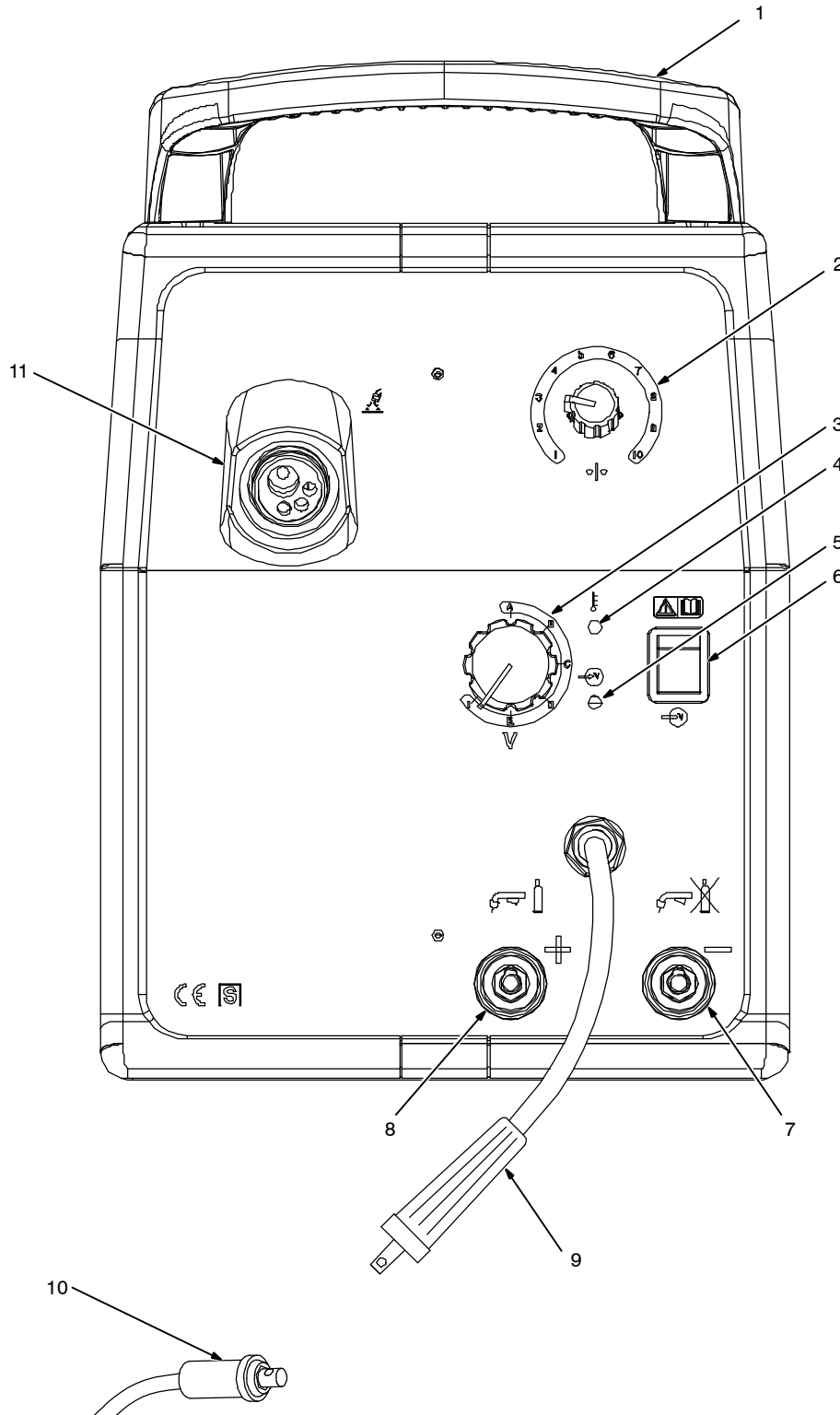













- 1 Handle
- 2 Wire Speed Control
- 3 6 Position Voltage Control
- 4 Thermal Overload Pilot Light
- 5 Input Voltage Pilot Light
- 6 Power Switch
- 7 Negative Power Source Terminal
- 8 Positive Power Source Connector
- 9 Polarity Change Over Cable
- 10 Work Connection
- 11 Torch Connector

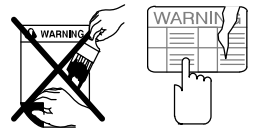
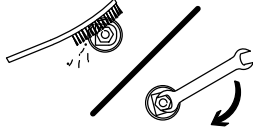

Ref. 956142985_2-A

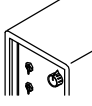
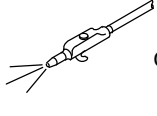
SECTION 5 – MAINTENANCE AND TROUBLESHOOTING

      		 Disconnect power before maintaining.	 <i>Maintain more often during severe conditions.</i>
	✓ = Check ◇ = Change ● = Clean ☆ = Replace * To be done by Factory Authorized Service Agent		
Every 3 Months	 <p>✓ ☆ Replace unreadable labels.</p>	 <p>✓ ● Clean and tighten weld terminals.</p>	 <p>✓ ☆ Repair or replace cracked weld cables.</p>
Every 6 Months	<p> <i>During heavy service clean monthly.</i></p> <p>  ● Blow out or vacuum inside. </p>   OR 		

5-1. Unit Overload

If unit is beyond capacity (excessive wire feed, shorted output, etc.) wire feeds but is not energized. Release gun trigger to reset this condition.

5-2. Troubleshooting

Trouble	Remedy
No weld output; wire does not feed.	Be sure line disconnect switch is On (see Section 3-12).
	Replace building line fuse or reset circuit breaker if open(see Section 3-12).
	Secure gun trigger connections.
	Check and replace Power switch if necessary
No weld output; overload light on	Thermostat TP1 open (overheating). Allow fan to run; the thermostat will close when the unit has cooled (see Section 3-5).
	An overload condition occurred. Release gun trigger (see Section 5-1).
Low weld output.	Connect unit to proper input voltage or check for low line voltage (see Section 3-12).
No wire feed.	Turn Wire Speed control to higher setting (see Section 4-1).
	Clear obstruction in gun contact tip or liner.
	Readjust drive roll pressure.
	Change to correct size drive rolls (see Section 3-8).
	Check gun trigger and leads. Repair or replace gun if necessary.
	Have Factory Authorized Service Agent check main control board.
Poor weld bead, or welding wire is noodle welding.	Check polarity setting for type of welding wire being used.

SECTION 6 – ELECTRICAL DIAGRAM

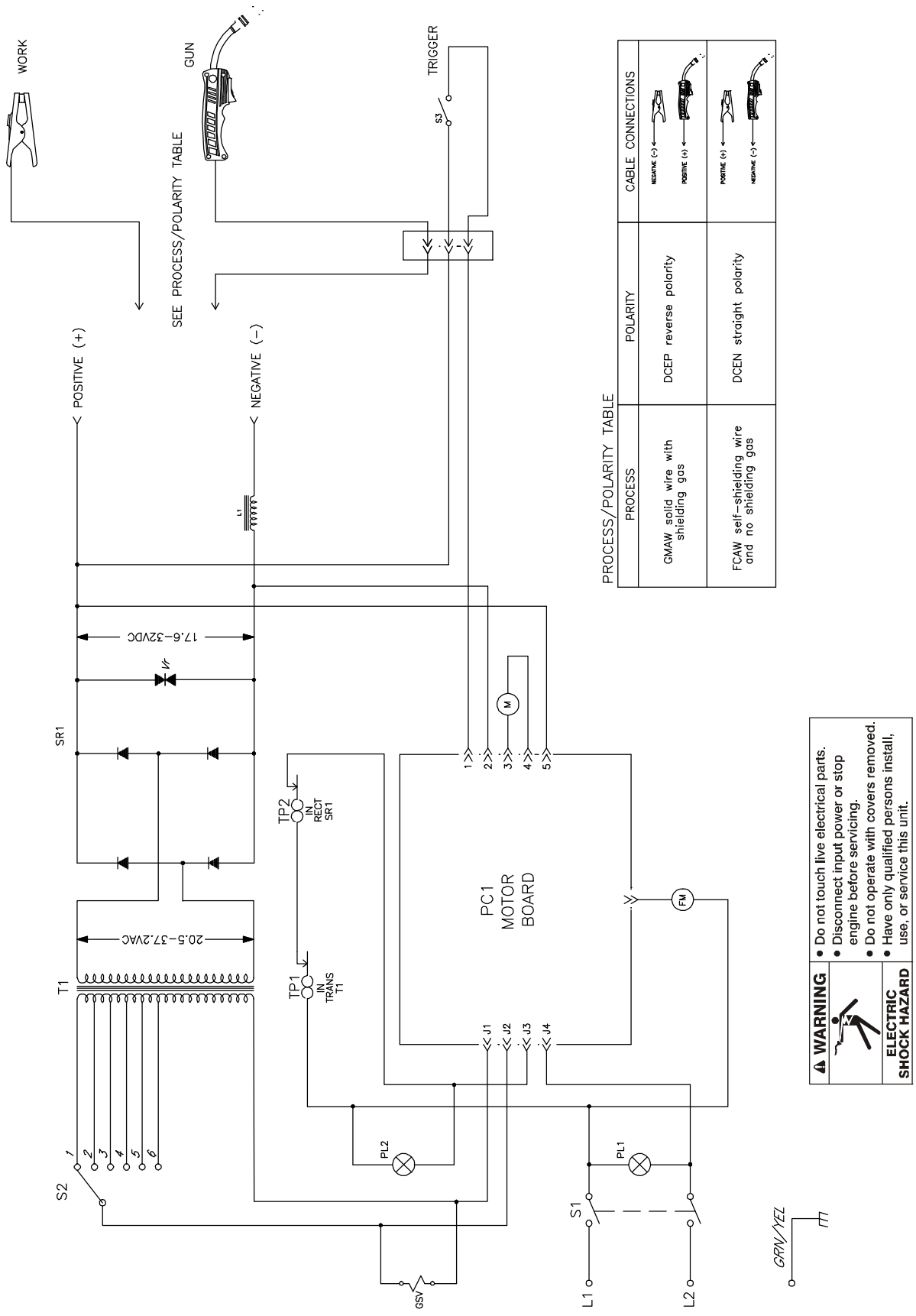

⚠ WARNING

- Do not touch live electrical parts.
- Disconnect input power or stop engine before servicing.
- Do not operate with covers removed.
- Have only qualified persons install, use, or service this unit.

ELECTRIC SHOCK HAZARD

Figure 6-1. Circuit Diagram For MigMatic 175

SECTION 7 – PARTS LIST

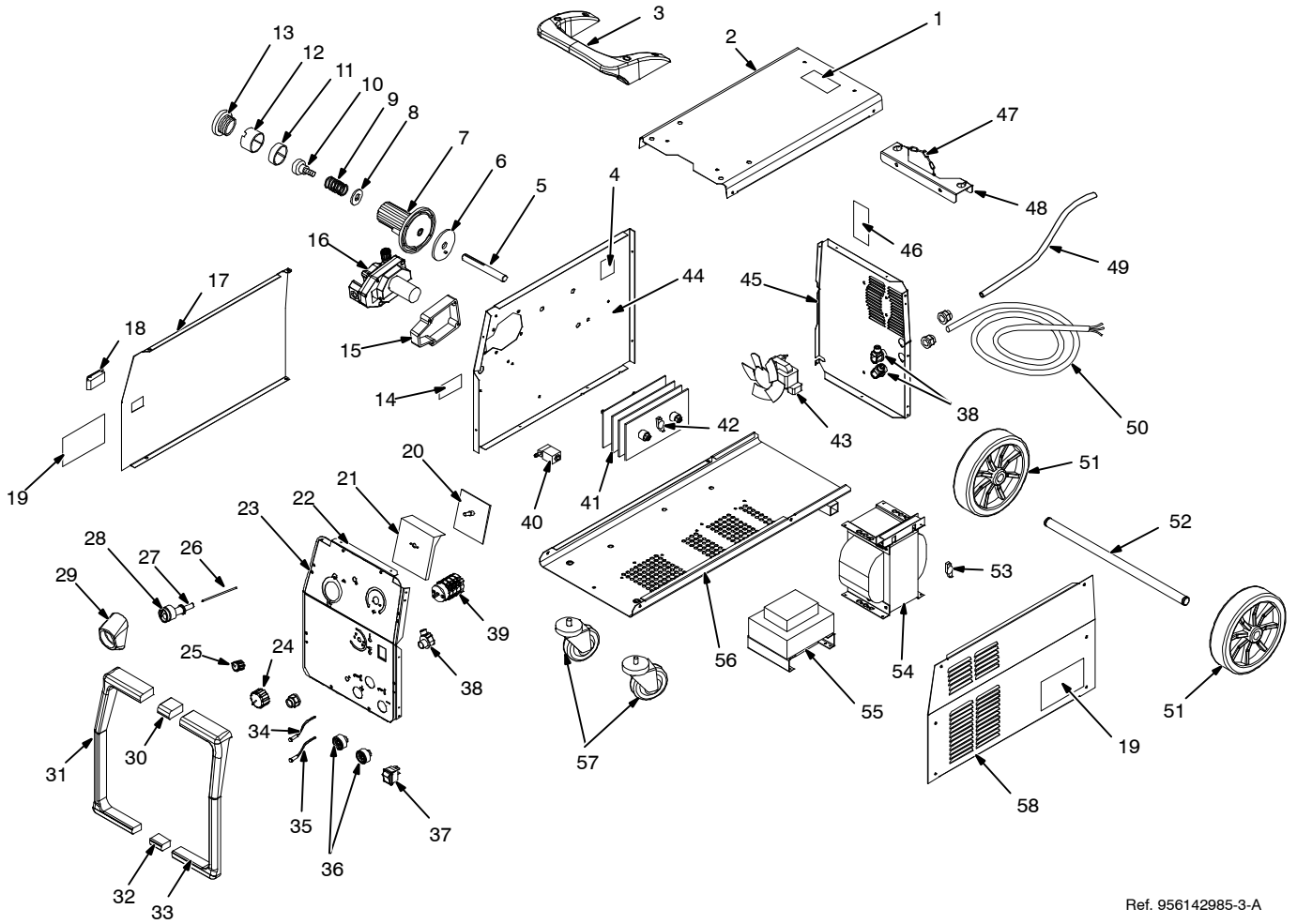

Ref. 956142985-3-A

Figure 7-1. Main Assembly

Item No.	Dia. Mkgs.	Part No.	Description	Quantity
----------	------------	----------	-------------	----------

Figure 7-1. Main Assembly

...	1	207235	Label, Warning Tilt	1
...	2	156121045	Cover	1
...	3	156002050	Handle	1
...	4	176106	Label, Fan	1
...	5	156012166	Spool Holder, Shaft	1
...	6	656009004	Washer, 17x70, Plastic	1
...	7	656102007	Hub	1
...	8	156009134	Washer, Flat	1
...	9	156032140	Spring, 17x2, 8x6 L=40	1
...	10	056020072	Handwheel Reel, w/Ring	1
...	11	156023170	Spacer, Spool Holder D.50 H.18	1
...	12	156023171	Spacer, Spool Holder D.50 H.30	1
...	13	156015027	Spool Nut, Plastic	1
...	14	+178937	Label, Warning Electric Shock	1
...	15	156008040	Housing, Motor Drive	1
...	16	057021026	Wire Drive System, 2 Rolls	1
...	17	+156007046	Side Panel, LH	1

+When ordering a component originally displaying a precautionary label, the label should also be ordered.

To maintain the factory original performance of your equipment, use only Manufacturer's Suggested Replacement Parts. Model and serial number required when ordering parts from your local distributor.

Item No.	Dia. Mkgs.	Part No.	Description	Quantity
Figure 7-1. Main Assembly (Continued)				
18		156034005	Latch, Side Panel	1
19		207233	Label, General Precautionary	1
20	PC1	057084040	Circuit Board, Motor Control	1
21		756084030	PCB Insulator	1
22		+156118087	Panel, Front	1
23		956142921	Nameplate, MigMatic 175	1
24		056020069	Knob, Pointer, D.40	1
25		207076	Knob, Pointer, D.22	1
26		556090046	Wire Guide, 2x5, L.78 Outlet	1
27		556090047	Spacer, L.26, Mini-Euro Connector	1
28		057052055	Connector, Mini-Euro, Quick Female	1
29		656014015	Plastic, Euro	1
30		756008017	Spacer, Upper Frame	1
31		156118088	Frame, LH	1
32		756008018	Spacer, Lower Frame	1
33		156118089	Frame, RH	1
34	PL2	056072082	Pilot, 230 VAC Lamp, Orange	1
35	PL1	056072078	Pilot, 230 VAC Lamp, White	1
36		056076270	Dinse, Socket, Female, 25MMQ	1
37	S1	056067267	Switch, Power	1
38		056091041	Strain Relief, D.20	1
39	S2	056067162	Switch, 16A 6 Pos	1
40	GSV	056061037	Solenoid, Gas Valve, 4W 230 VAC 50 HZ 1/8" FF	1
41	SR1	056050112	Rectifier, PMS 12/4/2 F	1
42	TP2	056159030	Thermostat, 100°	1
43	FM	057035012	Fan, 230 VAC	1
44		+156122093	Plate, Baffle	1
45		156118090	Panel, Rear	1
46		956142989	Rating Plate	1
47		156123006	Chain, D.4 L=660	1
48		156005183	Cylinder rack, Upper Support	1
49		656026143	Hose, D.5x10, 5 L=2500, Black	1
50		057014274	Line Cable, PVC, 3x2.5 M.2.5	1
51		056054082	Wheel, D.200, Hole D.20	1
52		156012167	Axle, Wheel Rear D.20 L.447	1
53	TP1	056159006	Thermostat, 127° 16A	1
54	T1	058021159	Transformer, 230 VAC 45x90 AL	1
55	L1	057098012	Choke, D.6 50x50 AL	1
56		+156006086	Base	1
57		056054091	Wheel, Caster D.85	1
58		+156122094	Side Panel, RH	1

+When ordering a component originally displaying a precautionary label, the label should also be ordered.

To maintain the factory original performance of your equipment, use only Manufacturer's Suggested Replacement Parts. Model and serial number required when ordering parts from your local distributor.

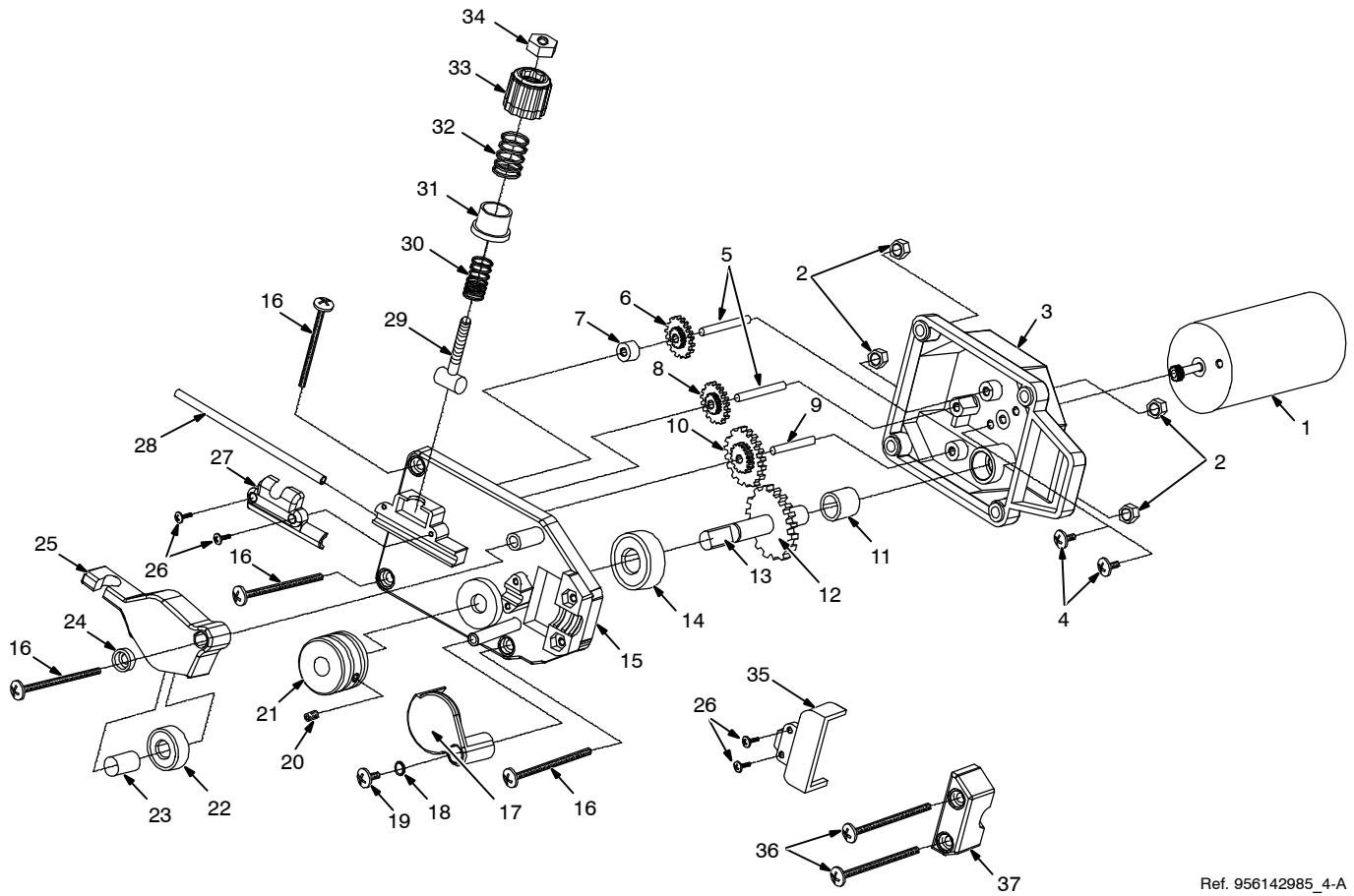

Ref. 956142985_4-A

Figure 7-2. Wire Drive Roll (2 Rolls)

Item No.	Dia. Mkgs.	Part No.	Description	Quantity
----------	------------	----------	-------------	----------

Figure 7-2. Wire Drive Roll (2 Rolls)

...	1	M	056126082	Motor, Gear	1
...	2		156018119	Nut, Hex M4, Zinc Steel	4
...	3		656161008	Cover, Rear, Gear Box Assembly	1
...	4		156019818	Screw, M3x8, Zinc Steel	2
...	5		156012140	Pin, D.4x35	2
...	6		156003040	Gear, Reducer	1
...	7		156008050	Spacer, Gear	1
...	8		156003041	Gear, Reducer	1
...	9		156012142	Pin, D.4x25	1
...	10		156003042	Gear, Reducer	1
...	11		156033035	Bushing, D.10x14, Brass	1
...	12		656003014	Drive Shaft, Central Gear / Drive Roll	1
...	13		156012168	Snap Ring, L.50	1
...	14		156017161	Bearing, D.10x26	1
...	15		656161009	Housing, Adapter Gun / Feeder	1
...	16		156019819	Screw, M4x60, Through Housing	4
...	17		156121046	Roll Cover	1
...	18		156009154	Washer, D.4 Zinced	1
...	19		156019820	Screw, 3.5x9.5 Zinc Steel	1
...	20		156019821	Screw, M5x8 Steel	1
...	21		156053047	Wire Drive Roll, D.9x30, 0.6-0.8 Knurled, See Figure 7-2, Table 7-1	1

To maintain the factory original performance of your equipment, use only Manufacturer's Suggested Replacement Parts. Model and serial number required when ordering parts from your local distributor.

Item No.	Dia. Mkgs.	Part No.	Description	Quantity
Figure 7-2. Wire Drive Roll (2 Rolls) (Continued)				
22		156017168	Bearing D.8x22	1
23		156012169	Pin, D.8x12	1
24		156009155	Washer, D.14, Upper Pressure Arm	1
25		656002020	Upper Pressure Arm Housing, PVC	1
26		156019822	Screw, 2.9x16	4
27		656081028	Cover, Wire Liner	1
28		056100110	Liner, Inlet	1
29		156012170	Tension Arm Threaded Assembly, Pinned	1
30		156032141	Spring, Tension Arm	1
31		156032142	Sleeve, Spring Housing	1
32		156032143	Spring, Wire Tensioning	1
33		656002021	Knob, Adjustment Tension	1
34		156018120	Nut, Tension Knob	1
35		656081029	Cover, Euro Adapter	1
36		156019823	Screw, M4x85 Zinc Steel	2
37		656081030	Bracket, Euro Adapter Pressure	1

To maintain the factory original performance of your equipment, use only Manufacturer's Suggested Replacement Parts. Model and serial number required when ordering parts from your local distributor.

Table 7-1. Drive Roll And Wire Guide Kits (2 Roll Model)

<i>Base selection of drive rolls upon the following recommended usages:</i>					
1. V-Grooved rolls for hard wire.					
2. U-Grooved rolls for soft and soft shelled cored wires.					
3. U-Cogged rolls for extremely soft shelled wires (usually hard surfacing types).					
4. V-Knurlled rolls for hard shelled cored wires.					
5. Drive roll types may be mixed to suit particular requirements (example: V-Knurlled roll in combination with U-Grooved).					
Wire Diameter			Drive Roll		Wire Guide
Metric	Fraction	Decimal	Part No.	Type	Inlet
0.6 / 0.8 mm	(.023 / .030 in.)	(.023 / .030 in.)	156053046*	V	056100110
0.6 / 0.8 mm	(.023 / .030 in.)	(.023 / .030 in.)	156053047	V-K	
0.8 / 1.0 mm	(.030 / .040 in.)	(.030 / .040 in.)	156053081	U	
* Included with power source.					

TRUE BLUE[®]

WARRANTY

Effective January 1, 2013
(Equipment with a serial number preface of MD or newer)

This limited warranty supersedes all previous Miller warranties and is exclusive with no other guarantees or warranties expressed or implied.

LIMITED WARRANTY – Subject to the terms and conditions below, ITW Welding Products Italy warrants to its original retail purchaser that new Miller equipment sold after the effective date of this limited warranty is free of defects in material and workmanship at the time it is shipped by Miller. THIS WARRANTY IS EXPRESSLY IN LIEU OF ALL OTHER WARRANTIES, EXPRESS OR IMPLIED, INCLUDING THE WARRANTIES OF MERCHANTABILITY AND FITNESS.

Within the warranty periods listed below, Miller will repair or replace any warranted parts or components that fail due to such defects in material or workmanship. Miller must be notified in writing within thirty (30) days of such defect or failure, at which time Miller will provide instructions on the warranty claim procedures to be followed.

Miller shall honor warranty claims on warranted equipment listed below in the event of such a failure within the warranty time periods. All warranty time periods start on the date the equipment was delivered to the original retail purchaser or one year after the equipment is shipped to a European distributor or eighteen months after the equipment is shipped to an International distributor.

1. 5 Years Parts — 3 Years Labor
 - * Original main power rectifiers only to include SCRs, diodes, and discrete rectifier modules with exclusion of STR, Si, STI, STH and MPi series.
2. 3 Years — Parts and Labor
 - * Engine Driven Welding Generators
(NOTE: Engines are warranted separately by the engine manufacturer.)
 - * Inverter Power Sources (Unless Otherwise Stated)
 - * Process Controllers
 - * Semi-Automatic and Automatic Wire Feeders
 - * Transformer/Rectifier Power Sources
 - * Water Coolant System (Integrated)
3. 2 Years — Parts
 - * Auto-Darkening Helmet Lenses (No Labor)
 - * Migmatic 175
 - * HF Units
 - * Water Coolant Systems (EU Models, Non-Integrated)
4. 1 Year — Parts and Labor Unless Specified
 - * Automatic Motion Devices
 - * Field Options
(NOTE: Field options are covered under True Blue[®] for the remaining warranty period of the product they are installed in, or for a minimum of one year — whichever is greater.)
 - * Induction Heating Power Sources, Coolers, and Electronic Controls/Recorders
 - * Motor Driven Guns (w/exception of Spoolmate Spoolguns)
 - * Positioners and Controllers
 - * Powered Air Purifying Respirator (PAPR) Blower Unit (No Labor)
 - * Racks
 - * Running Gear and Trailers
 - * Subarc Wire Drive Assemblies
 - * Water Coolant Systems (USA Models, Non-Integrated)
 - * Work Stations/Weld Tables (No Labor)
5. 6 Months — Parts
 - * Batteries

6. 90 Days — Parts
 - * Accessory (Kits)
 - * Canvas Covers
 - * Induction Heating Coils and Blankets
 - * MIG Guns
 - * Remote Controls
 - * Replacement Parts (No Labor)
 - * Spoolmate Spoolguns
 - * Cables and Non-Electronic Controls

Miller's True Blue[®] Limited Warranty shall not apply to:

1. **Consumable components; such as contact tips, cutting nozzles, contactors, brushes, switches, slip rings, relays or parts that fail due to normal wear.**
2. Items furnished by Miller, but manufactured by others, such as engines or trade accessories. These items are covered by the manufacturer's warranty, if any.
3. Equipment that has been modified by any party other than Miller, or equipment that has been improperly installed, improperly operated or misused based upon industry standards, or equipment which has not had reasonable and necessary maintenance, or equipment which has been used for operation outside of the specifications for the equipment.

MILLER PRODUCTS ARE INTENDED FOR PURCHASE AND USE BY COMMERCIAL/INDUSTRIAL USERS AND PERSONS TRAINED AND EXPERIENCED IN THE USE AND MAINTENANCE OF WELDING EQUIPMENT.

In the event of a warranty claim covered by this warranty, the exclusive remedies shall be, at Miller's option: (1) repair; or (2) replacement; or, where authorized in writing by Miller in appropriate cases, (3) the reasonable cost of repair or replacement at an authorized Miller service station; or (4) payment of or credit for the purchase price (less reasonable depreciation based upon actual use) upon return of the goods at customer's risk and expense. Miller's option of repair or replacement will be F.O.B., Factory at ITW Welding Products Group Europe or F.O.B. at a Miller authorized service facility as determined by Miller. Therefore no compensation or reimbursement for transportation costs of any kind will be allowed.

TO THE EXTENT PERMITTED BY LAW, THE REMEDIES PROVIDED HEREIN ARE THE SOLE AND EXCLUSIVE REMEDIES. IN NO EVENT SHALL MILLER BE LIABLE FOR DIRECT, INDIRECT, SPECIAL, INCIDENTAL OR CONSEQUENTIAL DAMAGES (INCLUDING LOSS OF PROFIT), WHETHER BASED ON CONTRACT, TORT OR ANY OTHER LEGAL THEORY.

ANY EXPRESS WARRANTY NOT PROVIDED HEREIN AND ANY IMPLIED WARRANTY, GUARANTY OR REPRESENTATION AS TO PERFORMANCE, AND ANY REMEDY FOR BREACH OF CONTRACT TORT OR ANY OTHER LEGAL THEORY WHICH, BUT FOR THIS PROVISION, MIGHT ARISE BY IMPLICATION, OPERATION OF LAW, CUSTOM OF TRADE OR COURSE OF DEALING, INCLUDING ANY IMPLIED WARRANTY OF MERCHANTABILITY OR FITNESS FOR PARTICULAR PURPOSE, WITH RESPECT TO ANY AND ALL EQUIPMENT FURNISHED BY MILLER IS EXCLUDED AND DISCLAIMED BY MILLER.





Owner's Record

Please complete and retain with your personal records.

Model Name

Serial/Style Number

Purchase Date

(Date which equipment was delivered to original customer.)

Distributor

Address

Country

Zip/Postal Code



For Service

Contact a *DISTRIBUTOR* or *SERVICE AGENCY* near you.

Always provide Model Name and Serial/Style Number.

Contact your Distributor for:

Welding Supplies and Consumables

Options and Accessories

Service and Repair

Replacement Parts

Owner's Manuals

Contact the Delivering Carrier to:

File a claim for loss or damage during shipment.

For assistance in filing or settling claims, contact your distributor and/or equipment manufacturer's Transportation Department.

ITW Welding Italy S.r.l.

Via Privata Iseo, 6/E

20098 San Giuliano

Milanese, Italy

Phone: 39 (0) 2982901

Fax: 39 (0) 298290-203

email: miller@itw-welding.it

